

Operating Instructions

# TRACHEOFIRST® PRO TRACHEOPORT® PRO

English



## Table of contents

<b>1.0</b>	<b>Introduction</b> .....	<b>4</b>
1.1	Notes on operating instructions.....	4
1.2	Explanation of pictures and symbols.....	5
1.3	Intended purpose.....	8
1.4	Function.....	10
1.5	Intended users.....	10
1.6	Scope of delivery.....	11
1.7	Transport and storage.....	11
<b>2.0</b>	<b>Notes for your safety</b> .....	<b>12</b>
2.1	General safety instructions.....	12
2.2	Danger for users, patients, and third parties.....	12
2.3	Avoiding damage to the device.....	14
<b>3.0</b>	<b>Setting up and starting up</b> .....	<b>15</b>
3.1	Device overview.....	15
3.1.1	Front/rear view (with TRACHEOFIRST® PRO / TRACHEOPORT® PRO secretion canister).....	15
3.1.2	Front/rear view (with Serres® refitting set).....	16
3.1.3	Control panel.....	17
3.1.4	Hose connection.....	17
3.2	Preparing the device.....	17
3.3	Preparing the device with the Serres® refitting set.....	18
3.4	Charging the battery.....	19
3.5	Charging using the mains power unit.....	19
3.6	Connecting/removing the secretion canister TRACHEOFIRST® PRO / TRACHEOPORT® PRO and the hoses.....	20
3.6.1	Connecting the TRACHEOFIRST® PRO / TRACHEOPORT® PRO secretion canister.....	20
3.6.2	Notes on the bacterial and viral filter.....	22
3.6.3	Removing the bacterial and viral filter.....	22
3.6.4	Inserting the bacterial and viral filter.....	22
3.6.5	Connecting the hose adapter.....	23
3.6.6	Holder for suction hose.....	23
3.7	Connecting the Serres® refitting set.....	23
3.7.1	Connection.....	24
3.7.2	Removal.....	25
3.7.3	Notes on the bacterial and viral filter for the Serres® refitting set.....	26

<b>4.0</b>	<b>Operation</b> .....	<b>27</b>
4.1	Switching on the device .....	27
4.2	Switching off the device .....	27
4.3	Adjusting the vacuum .....	27
4.4	Suction .....	28
4.5	After use .....	29
4.5.1	Removing the TRACHEOFIRST® PRO / TRACHEOPORT® PRO secretion canister .....	29
4.5.2	Removing the suction hose .....	29
4.5.3	Removing the hose adapter .....	29
<b>5.0</b>	<b>Cleaning and disinfection</b> .....	<b>30</b>
5.1	Safety instructions for reprocessing .....	30
5.1.1	General safety instructions .....	30
5.1.2	Danger for users, patients, and third parties .....	30
5.1.3	Avoiding damage to the device .....	30
5.2	Preparing/completing reprocessing .....	31
5.3	Prepare surfaces .....	32
5.3.1	Overview .....	32
5.3.2	Selecting process chemicals .....	32
5.3.3	Pre-cleaning .....	33
5.3.4	Wipe cleaning .....	33
5.3.5	Wipe disinfection .....	33
5.4	Reprocessing the accessories .....	34
5.4.1	Replacing accessories .....	34
<b>6.0</b>	<b>Maintenance and service</b> .....	<b>36</b>
6.1	Function check .....	36
6.2	Sending in the device .....	36
6.3	Handling batteries .....	36
<b>7.0</b>	<b>Troubleshooting</b> .....	<b>37</b>
<b>8.0</b>	<b>Accessories and consumables</b> .....	<b>39</b>
8.1	Accessories .....	39
8.2	Consumables .....	39
<b>9.0</b>	<b>Disposal/recycling</b> .....	<b>40</b>
9.1	Expected service life .....	40
<b>10.0</b>	<b>Technical data</b> .....	<b>41</b>
10.1	TRACHEOFIRST® PRO .....	41
10.2	TRACHEOPORT® PRO .....	42
10.3	Bacterial and viral filter .....	43
<b>11.0</b>	<b>Notes on EMC</b> .....	<b>44</b>
<b>12.0</b>	<b>Legal notice</b> .....	<b>45</b>

## 1.0 Introduction

### 1.1 Notes on operating instructions



These operating instructions contain important notes on how to operate the TRACHEOFIRST® PRO and TRACHEOPORT® PRO safely, correctly, and effectively.

These operating instructions are designed for training and instructing new operating personnel in the use of the system, and also for use as a reference manual. This document may only be reprinted, either in part or in whole, with written permission from Andreas Fahl Medizintechnik-Vertrieb GmbH.

**These operating instructions must always be kept available near the device.**



Care, periodic tests, regular cleaning, and proper application are essential. They guarantee the operational safety and usability of the TRACHEOFIRST® PRO and the TRACHEOPORT® PRO.

Maintenance, repairs, and periodic tests may only be carried out by persons who have the appropriate technical knowledge and are familiar with the product. The person in question must possess the necessary test devices and original spare parts required to carry out these measures.



Read chapter "2.0 Notes for your safety" on page 12 before using the device for the first time. This will help you to avoid potentially dangerous situations.

The products TRACHEOFIRST® PRO and TRACHEOPORT® PRO bear CE marking CE 0124 according to the EU Council Directive 93/42/EEC concerning medical devices and meet the basic requirements of Annex I to this directive.

The products TRACHEOFIRST® PRO and TRACHEOPORT® PRO comply with all applicable requirements of Directive 2011/65/EU restricting the use of certain hazardous substances in electrical and electronic equipment ("RoHS").

The quality management system at Andreas Fahl Medizintechnik-Vertrieb GmbH has been certified according to the international standard EN ISO 13485.

Subject to alterations; errors excepted.

These operating instructions are valid for the following devices:

Mains-powered suction device:

TRACHEOFIRST® PRO 67800

Battery-powered suction device:

TRACHEOPORT® PRO 63900













## 1.2 Explanation of pictures and symbols

### In the operating instructions

	<b>DANGER</b> Warning of a danger that will result in immediate fatal or serious injury. Observe the necessary measures.
	<b>WARNING</b> Warning of a danger that can cause fatal or serious injury. Observe the necessary measures.
	<b>CAUTION</b> Warning of a danger that can cause minor injury. Observe the necessary measures.
	<b>NOTICE</b> Notice of a danger that can damage the product or other objects. Observe the necessary measures.
	Warning of a danger that can cause fatal or serious injury.
	Notice of potential material damage.
	Useful information on the handling of the device.
1.	Action. Proceed step by step.
•	Numeration.
»	Result of an action.
	Move, plug in this direction.
	Engage, check correct fit.

### On device, type plate, and packaging

	Follow operating instructions (blue)
	Consult operating instructions
	Warning; pay special attention
	This device complies with the relevant requirements of EU regulations.
	This device complies with the relevant requirements of EU regulations.
	<p>UL Listing Mark            MEDICAL — GENERAL MEDICAL EQUIPMENT            AS TO ELECTRICAL SHOCK, FIRE AND MECHANICAL HAZARDS ONLY IN ACCORDANCE WITH            ANSI/AAMI ES60601-1 (2005) + AMD 1 (2012)            CAN/CSA-C22.2 No. 60601-1 (2014)            IEC 60601-1-6 (2013)            ANSI/AAMI HA60601-1-11 (2015)</p>

	Manufacturer
	Date of manufacture Country of manufacture
	Distributor
<b>REF</b>	Reference number
<b>UDI</b>	Unique Device Identifier of a medical device
<b>MD</b>	Medical device
<b>SN</b>	Serial number
<b>LOT</b>	Batch code
	Use-by date
<b>IP21</b>	Protected against ingress of: <ul style="list-style-type: none"> <li>• Solid foreign particles <math>\varnothing \geq 12.5</math> mm</li> <li>• Dripping water from above</li> </ul>
	Type BF applied part
	Professional disposal
	Not for reuse (designed for repeated use for a single patient)
	Non-sterile
<b>PATIENT</b>	Connection for suction hose / patient
	Device does not contain latex
	Short-term operation (max. 30 minutes ON, min. 30 minutes OFF)
	Protection class II device
	On/off button
	Direction of vacuum setting
-	min. vacuum setting

	max. vacuum setting
	Fragile, handle with care
	Keep dry
	Keep away from sunlight
	Temperature limit
	Humidity limitation
	Atmospheric pressure limitation
	Do not use if the packaging is damaged
	The packaging configuration of this medical device has been changed by the company Andreas Fahl Medizintechnik-Vertrieb GmbH.





### UDI application identifier

(01)	UDI-DI: Identification of the manufacturer and the device
(10)	Batch code
(11)	Date of manufacture
(17)	Expiry date
(21)	Serial number
(30)	Quantity in pieces

### On the battery

	This product complies with the relevant requirements of the EU Directives.
	Contains lead, recyclable
	Contains lead, dispose of professionally
	Certification marking (Recognized Component Mark)

## On the mains power unit

	Protection class II device
	Professional disposal
	This product complies with the relevant requirements of the EU Directives.
	Devices with this symbol may only be used indoors (dry surroundings)
IP52	Protected against: <ul style="list-style-type: none"> <li>• Dust in harmful quantities</li> <li>• Dripping water from above when the housing is tilted up to 15°</li> </ul>
	Safety test seal

## 1.3 Intended purpose

<b>Product name:</b>	TRACHEOFIRST® PRO TRACHEOPORT® PRO
<b>Main functions:</b>	Temporary and spontaneous suction of aspirate (i.e., secretion, blood, serous fluids, pieces of food) from the oral cavity, pharynx and the bronchial system
<b>Intended use:</b>	Suction of the upper and lower respiratory tract
<b>Intended users / user profile:</b>	<ul style="list-style-type: none"> <li>• Healthcare professionals</li> <li>• Non-medical users, e.g., patients and/or relatives (after instruction by a doctor)</li> </ul>
<b>User training:</b>	<p>The TRACHEOFIRST® PRO and the TRACHEOPORT® PRO may be operated and used only by instructed and appropriately trained persons.</p> <p>Suction is performed after the patient, or the assistant / caregiver has been instructed by a doctor, taking into account the specific vacuum required depending on the age.</p>
<b>Intended patient target groups:</b>	Patients of all age groups with and without restrictions
<b>Medical conditions to be diagnosed, treated or monitored:</b>	Not applicable
<b>Organ(s) applied to:</b>	<ul style="list-style-type: none"> <li>• Upper respiratory tract (nose, nasal cavity, pharynx)</li> <li>• Lower respiratory tract (larynx, trachea, bronchial system)</li> </ul>
<b>Duration of application:</b>	Temporary use on the patient (< 60 min.)
<b>Use environment:</b>	<ul style="list-style-type: none"> <li>• Home healthcare environment (homecare area)</li> <li>• Outpatient and inpatient care</li> </ul>



<b>Patient selection criteria:</b>	<ul style="list-style-type: none"> <li>• Patients who benefit from suction of the upper and/or lower respiratory tracts</li> </ul>
<b>Indications:</b>	<p>In cases of damage to respiratory and coughing functions with dysfunctional elimination of tracheal, bronchial, or oral secretion:</p> <ul style="list-style-type: none"> <li>• suction after tracheotomy</li> <li>• suction after laryngectomy</li> <li>• suction in case of impaired respiratory function</li> </ul> <p>Suction in case of muscular and/or neurological diseases:</p> <ul style="list-style-type: none"> <li>• suction in the case of dysphagia</li> <li>• Suction of blood, secretion and pieces of food from the oral cavity, pharynx, and the bronchial system</li> </ul>
<b>Medical contra-indications:</b>	<p>Not suitable for:</p> <ul style="list-style-type: none"> <li>• continuous operation in cases of drainage in the low-vacuum range (e.g., cardiothoracic drainage or wound drainage)</li> <li>• permanent endoscopic use</li> <li>• vacuum extraction</li> <li>• smoke evacuation</li> <li>• liposuction</li> <li>• emergency or rescue operation</li> </ul>
<b>Other contra-indications:</b>	<p>Not suitable for:</p> <ul style="list-style-type: none"> <li>• suctioning outdoors / during transport</li> <li>• suction of flammable, corrosive, and explosive substances</li> <li>• suction in potentially explosive atmospheres</li> </ul>
<b>Undesirable side-effects:</b>	<p>The following complications may arise during suction:</p> <ul style="list-style-type: none"> <li>• nasopharyngeal bleeding</li> <li>• vocal cord injuries</li> <li>• tracheal injuries</li> <li>• hypoxaemia</li> <li>• cardiovascular instability</li> <li>• bradycardia, arrhythmia, and asystole (provoked by vagus nerve stimulation)</li> <li>• tachycardia (provoked by stress)</li> <li>• gagging, nausea, vomiting, and coughing</li> <li>• hospital-acquired infection (HAI) of the airways</li> <li>• seizures in patients prone to convulsions</li> </ul>
<b>Warnings:</b>	<p>See chapter "2.0 Notes for your safety" on page 12 in the valid instructions for use of the product.</p>
<b>The product is:</b>	active
<b>Sterility / specific microbial state:</b>	Non-sterile device
<b>Single-use device / reprocessing:</b>	<p>The device is intended for multiple use. The device and part of the accessories are reusable. For information on reprocessing, cleaning and disinfection, please see the operating instructions.</p>

## 1.4 Function

### General description

The devices are mobile, portable medical suction devices designed for temporary, preferably spontaneous suction of the upper and lower respiratory tract. The suction material (including secretion, blood, serous fluids, and food particles) is temporarily collected in a collection canister and then disposed of.

### Principles of operation and its mode of action

The devices are electrically operated and take their medical effect by generating vacuum and suction performance. The devices are operated by an electromotive maintenance-free piston pump.

The devices supply a suction capacity of max. 27 l/min  $\pm$  3 l/min and can build up a maximum vacuum of -80 kPa  $\pm$  -5 kPa (-800 mbar  $\pm$  -50 mbar; -600 mmHg  $\pm$  -37.5 mmHg).

The TRACHEOFIRST® PRO is a mains-powered bronchial suction unit, the operation of which requires the mains power unit (100 – 240 V) to be connected to the power supply grid.

The TRACHEOPORT® PRO is a bronchial suction unit powered by a rechargeable battery, which can be operated either using the permanently installed rechargeable battery or an external DC power supply (13.8 V) as desired. To charge the battery, the mains power unit (100 – 240 V) needs to be plugged into the power supply grid.

The devices are designed for short-term operation. The devices must be switched off after no more than 30 minutes to prevent them from overheating. They must remain switched off for a period of at least 30 minutes to ensure adequate cooling.

During operation, the pump generates a vacuum in the TRACHEOFIRST® PRO / TRACHEOPORT® PRO and within the hose system, with the help of which secretion, blood and body fluids as well as liquid and solid pieces of food are suctioned off. The fluid is collected in the secretion canister of the TRACHEOFIRST® PRO / TRACHEOPORT® PRO.

The vacuum setting allows you to infinitely adjust the final vacuum and thus the suction capacity. The vacuum gauge shows the set vacuum.

The TRACHEOFIRST® PRO and TRACHEOPORT® PRO cannot be operated when in motion and must therefore be kept stationary when operated.

### TRACHEOFIRST® PRO / TRACHEOPORT® PRO secretion canister:

The TRACHEOFIRST® PRO / TRACHEOPORT® PRO secretion canister is fastened to the side of the device and connects directly to the suction device. The user then merely needs to connect the suction hose to the TRACHEOFIRST® PRO / TRACHEOPORT® PRO canister lid. A bacterial and viral filter installed in the device prevents bacteria, viruses and liquids from entering the device.

### Key features:

- Vacuum generation (high vacuum)
- Suction capacity (high flow)

## 1.5 Intended users

The TRACHEOFIRST® PRO and TRACHEOPORT® PRO may be operated by the patient themselves, a patient's relative, the mobile care service, a nurse or trained medical personnel.

Suctioning is performed after the patient or the assistant/caregiver has been instructed by a doctor, taking into account the specific vacuum required depending on the patient's age.

Prior to application, the user must be familiar with the device. Please note country-specific requirements and regulations.

Andreas Fahl Medizintechnik-Vertrieb GmbH recommends: Have an authorised person show you how to use the device.

## 1.6 Scope of delivery

- ☞ Please check the contents for completeness immediately upon receipt (see delivery note).

### 67800 TRACHEOFIRST® PRO

- 1 x basic device with secretion canister
- 2 x bacterial and viral filter
- 1 x suction hose (TRACHFLOW® Line Pro)
- 1 x hose adapter
- 1 x mains power unit
- 1 x operating instructions

### 63900 TRACHEOPORT® PRO

- 1 x basic device with secretion canister
- 2 x bacterial and viral filter
- 1 x suction hose (TRACHFLOW® Line Pro)
- 1 x hose adapter
- 1 x mains power unit
- 1 x operating instructions

## 1.7 Transport and storage

Only transport the device in a shipping carton that is padded and offers sufficient protection.

If damage occurs during transport:

1. Document and report the transport damage.
2. Get in touch with your contact person at Andreas Fahl Medizintechnik-Vertrieb GmbH.

### Ambient conditions for transport and storage:

- Temperature: -30...+70 °C
- Relative humidity: 5...90%
- Air pressure: 700...1060 hPa

## 2.0 Notes for your safety

The safety of the TRACHEOFIRST® PRO and the TRACHEOPORT® PRO complies with the recognised rules of technology and the guidelines of the Medical Devices Act.

### 2.1 General safety instructions

Report all serious incidents that have occurred in connection with this device to the manufacturer and your national competent authority.

Make yourself familiar with the device in good time so that you are capable of operating it when it is needed.

**Only a fully functional product meets the safety requirements of users, patients, and third parties. Therefore, read the following instructions carefully:**

Never operate the device if it shows any obvious safety defects.

### 2.2 Danger for users, patients, and third parties

#### **⚠ WARNING**

**Ensure that the device is always operational and ready for use!**

The patient could suffocate.

- Ensure that the device is always ready for use.
- Place the device where it will be easily accessible.
- Make sure that the mains power unit is working.
- Always carry out a function check before using the device.
- Always have another suction device ready on hand.
- Observe the notes on electromagnetic compatibility (EMC).
- Only use the recommended original accessories and original spare parts.
- To ensure safe use of the device, only use the secretion canister systems described in the operating instructions.

#### **⚠ WARNING**

**Avoid misuse!**

Your patient can be severely injured.

- Use the device only as intended.
- Never use the device for low-vacuum suction.
- Only use the device with transparent suction hoses.
- Too many suction operations may cause minor bleeding.
- Always observe the applicable guidelines.
- Using the device on children requires a lower vacuum setting. Observe the instructions issued by the attending physician.
- Observe the notes on hygiene and cleaning.

#### **⚠ WARNING**

**Reduce the risk of infection for you and your patients!**

Deadly diseases can be transmitted.

- Always wear disposable gloves.
- Never use components which are marked with ⓧ more than once.
- Always use a suitable sterile suction catheter for suctioning. The suction hose must never come into direct contact with the application site.

- Only use sterile packaged parts when the packaging is undamaged.
- Never operate the device without a bacterial and viral filter. Before each use, check that the bacterial and viral filter is dry and clean to ensure proper functioning.

**⚠ WARNING**

**Protect yourself against an electric shock!**

Damage from incorrect power supply.

- Risk of burns, cardiac arrhythmias, and even fatal injury.
- Before switching on the device, make sure that the power supply grid is designed for connecting a device that operates in the range from 100 - 240 VDC at a grid frequency of 50/60 Hz. Use only the included mains power unit for the device (type: GTM46402-3713.4).
- Do not operate the device in damp rooms, bathrooms, or showers. Keep the mains power unit, control panel, and mains power connection point dry.
- Do not use the device in areas where there could be a torrent of water.
- Never submerge the device in water or other fluids.
- Do not operate the device if it has been dropped. In this case, please clean the device and send it in to Andreas Fahl Medizintechnik-Vertrieb GmbH for repair.
- Disconnect the device from the mains power supply prior to cleaning or disinfection.
- Always check the device and mains power unit for damage before use. Do not operate the device if you notice any damage. In this case, please clean the device and send it in to Andreas Fahl Medizintechnik-Vertrieb GmbH for repair.
- Ensure that no liquid penetrates the device. If liquid has entered the device, operation of the device must cease immediately. In this case, please clean the device and send it in to Andreas Fahl Medizintechnik-Vertrieb GmbH for repair.
- The TRACHEOFIRST® PRO and TRACHEOPORT® PRO cannot be sterilised.
- Only use the mains power unit in dry surroundings.
- Only use the mains power unit according to the operating instructions.
- Only use original accessories and original spare parts.
- Observe the specifications regarding periodic tests in chapter "6.0 Maintenance and service" on page 36.
- Assembly, new settings, alterations, extensions, and repairs may only be carried out by authorised persons.
- Do not modify the device without the manufacturer's permission.

**⚠ WARNING**

**Explosion and fire hazard!**

There is a risk of burns and injuries.

- Never suction any explosive, flammable, or corrosive gases or liquids. Refer to the explanations under Intended Purpose.
- Never operate the product in potentially explosive areas or areas that are oxygenated.
- Only use original accessories and original spare parts from Andreas Fahl Medizintechnik-Vertrieb GmbH.

**⚠ WARNING****Risk of suffocation or strangling for children and animals through accessory parts!**

Small parts may cause children or animals to suffocate or be injured.

- Hoses or power cables may strangle people or animals, especially if the hoses or cables are particularly long.
- Keep unauthorised persons away from the device during suction.
- Keep children away from swallowable small parts.
- Keep the device and all its accessories out of reach of children when not using it.

**⚠ WARNING****Contact may cause allergic reactions!**

The materials used have been tested for their tolerability. In very rare cases, contact with accessible materials on the device and its accessories may cause allergic reactions. This applies in particular to contact injuries in conjunction with prolonged contact. If this occurs, seek medical attention immediately.

**⚠ WARNING****Tripping hazard due to cables!**

Injuries and fractures are possible.

- Lay connecting cables properly.

## 2.3 Avoiding damage to the device

**⚠ NOTICE****Damage to device due to heat build-up!**

The device may become damaged.

- Do not cover the device during suction.
- Keep the device and the mains power unit away from other heat sources.
- Do not place the device directly next to other devices as this may cause excessive heating of the device.

**⚠ NOTICE****Storage and operation in an unsuitable environment!**

The device may become damaged.

- Please observe the ambient conditions regarding transport, storage, operation, and charging of the battery.
- After transporting the device at low temperatures, keep the device at room temperature for at least six hours before initial start-up. If the device has not acclimatised, it may suffer internal damage.

**⚠ NOTICE****Damage to the device through improper use!**

The device may become damaged.

- Ensure that no liquid penetrates the device. Once liquid has penetrated the device, it may no longer be operated. In this case, please clean the device and send it in to Andreas Fahl Medizintechnik-Vertrieb GmbH for repair.
- Always place the device on firm, level surface. The device must always be in a vertical position when you use it.
- Only use mains power units and extension cables that are in perfect condition.

## 3.0 Setting up and starting up

**i** Please observe that insufficient battery charge can result in damage to the battery.

1. Fully charge the battery for the TRACHEOPORT® PRO before using the device.

### 3.1 Device overview

#### 3.1.1 Front/rear view (with TRACHEOFIRST® PRO / TRACHEOPORT® PRO secretion canister)

##### Front view

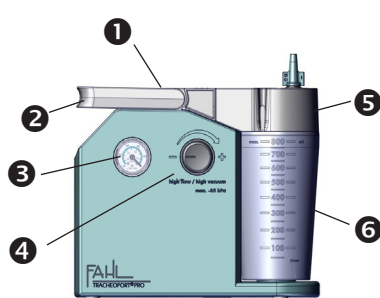

- 1 Control panel
- 2 Carry handle
- 3 Vacuum gauge
- 4 Vacuum regulator (from - to +)
- 5 Canister lid TRACHEOFIRST® PRO / TRACHEOPORT® PRO
- 6 TRACHEOFIRST® PRO / TRACHEOPORT® PRO secretion canister

##### Rear view

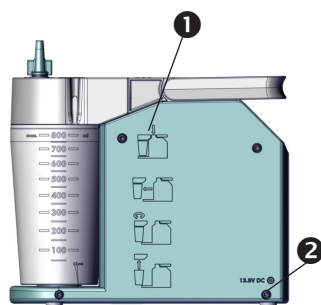

- 1 Brief instructions
- 2 Connection for the mains power unit

#### TRACHEOFIRST® PRO / TRACHEOPORT® PRO secretion canister

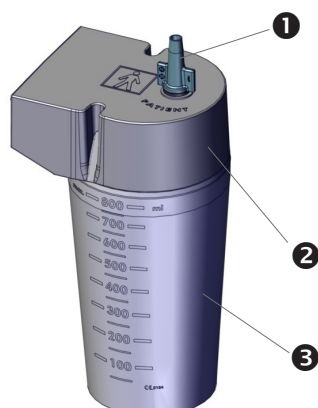

- 1 Hose adapter for connection of the suction hose
- 2 TRACHEOFIRST® PRO / TRACHEOPORT® PRO canister lid
- 3 TRACHEOFIRST® PRO / TRACHEOPORT® PRO secretion canister

### 3.1.2 Front/rear view (with Serres® refitting set)

#### Front view

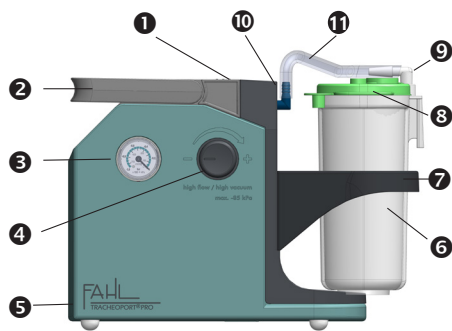

- ❶ Control panel
- ❷ Carry handle
- ❸ Vacuum gauge
- ❹ Vacuum regulator (from - to +)
- ❺ Connection for the mains power unit
- ❻ Serres® external canister
- ❼ Support for Serres® external canister
- ❽ Serres® suction bag
- ❾ Angle (connection for the disposable suction hose)
- ❿ Bacterial and viral filter for Serres® refitting set
- ⓫ Vacuum connection hose

#### Rear view

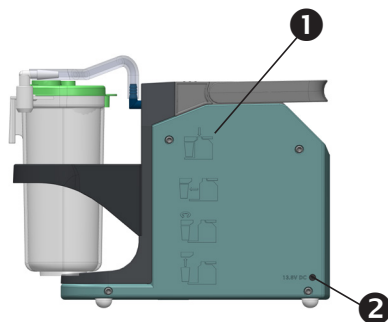

- ❶ Brief instructions
- ❷ Connection for the mains power unit

#### Serres® canister system

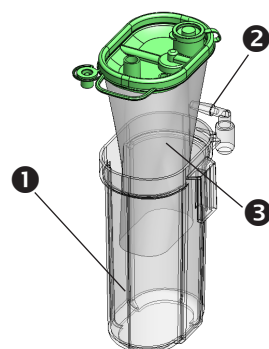

- ❶ Serres® external canister
- ❷ Angle (connection for the disposable suction hose)
- ❸ Serres® suction bag



### 3.1.3 Control panel

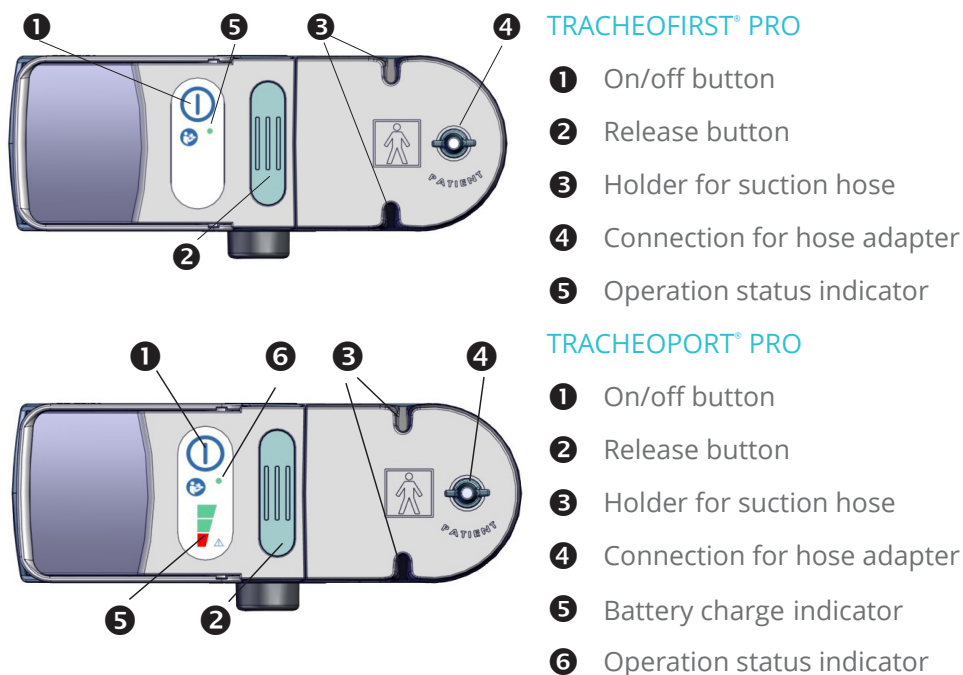

- ☞ The battery charge level of the TRACHEOPORT® PRO must be visually monitored by checking the indicator.
- ☞ If only the red LED lights up although the battery has been charged for a long time, the battery is defective.

### 3.1.4 Hose connection

Hose adapter (REF 60530)

- ☞ Connect the suction hose to the hose adapter.

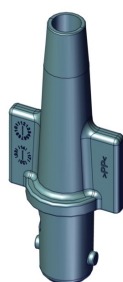

## 3.2 Preparing the device

1. After transporting the device at low temperatures, keep it at room temperature for at least six hours before initial start-up.
2. Take the device and the accessories out of the packaging.
3. Read the safety notes before initial start-up.
4. Check the device for any transport damage.
5. If the device is damaged: Send in the device for repair via the dealer from whom you purchased the device.
6. Place the device on a safe and even surface.
7. Check the mains power unit for damage.

8. Replace a defective mains power unit immediately.
9. For the TRACHEOPORT® PRO: The battery must be fully charged; see chapter “3.4 Charging the battery” on page 19.
10. Operate the device only when the bacterial and viral filter is inserted and the TRACHEOFIRST® PRO / TRACHEOPORT® PRO secretion canister is connected. The device is delivered with the bacterial and viral filter as well as the TRACHEOFIRST® PRO / TRACHEOPORT® PRO secretion canister already connected/inserted. Always keep an extra bacterial and viral filter on hand.
11. Remove the TRACHEOFIRST® PRO / TRACHEOPORT® PRO secretion canister according to “4.5.1 Removing the TRACHEOFIRST® PRO / TRACHEOPORT® PRO secretion canister” on page 29.
12. Before using it for the first time, clean the TRACHEOFIRST® PRO / TRACHEOPORT® PRO secretion canister; see chapter “5.0 Cleaning and disinfection” on page 30.
- ☞ Recommendation: Before suction, fill some water (approx. 10–20 ml) into the TRACHEOFIRST® PRO / TRACHEOPORT® PRO secretion canister. This will prevent the secretion from drying out.
13. Place the TRACHEOFIRST® PRO / TRACHEOPORT® PRO secretion canister into the canister guides on the base of the device according to chapter “3.6.1 Connecting the TRACHEOFIRST® PRO / TRACHEOPORT® PRO secretion canister” on page 20.
14. Connect the hose adapter and the suction hose.
15. Attach the suction hose to the TRACHEOFIRST® PRO / TRACHEOPORT® PRO canister lid.

### 3.3 Preparing the device with the Serres® refitting set

1. After transporting the device at low temperatures, keep the device at room temperature for at least six hours before initial start-up.
2. Take the device and the accessories out of the packaging.
3. Read the safety notes before initial start-up.
4. Check the device for any transport damage.
5. If the device is damaged: Send in the device for repair via the dealer from whom you purchased the device.
6. Place the device on a safe and even surface.
7. Check the mains power unit for damage.
8. Replace a defective mains power unit immediately.
9. For the TRACHEOPORT® PRO: The battery must be fully charged; see chapter “3.4 Charging the battery” on page 19.
10. Only operate the device when the bacterial and viral filter for the Serres® refitting set is inserted and the disposable canister system (Serres®) is connected. The device is delivered with the bacterial and viral filter cartridge already inserted. Always keep an extra bacterial and viral filter on hand.
11. Attach the support for the Serres® external canister directly to the device.
12. Insert the disposable suction bag into the external canister. Observe the operating instructions of the disposable canister system. The external canister must be placed on a solid surface.
13. Check whether the foil of the suction bag is completely inserted into the external canister and the lid fits tightly on the external canister.
14. Insert the disposable canister system (external canister with suction bag) into the support for the canister system.

15. Attach the vacuum connection hose to the bacterial and viral filter and to the angle on the external canister of the disposable system.
16. Attach the disposable suction hose to the suction bag.

### 3.4 Charging the battery

- ☞ The battery's charge level is shown by the LED battery charge indicator on the control panel.
  - ☞ As the integrated battery is not automatically kept at fully operational level, you will need to check the battery charge level regularly and, when necessary, have service personnel replace it. The battery may be replaced by authorised and trained service personnel only. You can check the battery status by switching on the device.
  - ☞ The battery must be fully charged prior to first use.
1. Charge the battery at the latest when the battery charge indicator's red LED lights up.



#### Understanding the battery charge level:

- Two green LEDs: > 60%
- One green LED: 20-60%
- One red LED: <20%

#### During charging:

While the battery is charging, both green LEDs are lit.

2. Only use the enclosed mains power unit (REF 011.1363.0).
3. Please observe the notes in chapter "6.3 Handling batteries" on page 36. Try to avoid charging the battery only briefly, as this can damage the battery.

During battery recharging, full suction capacity of the device is still available.

If the battery is fully discharged, you can operate the device using the mains power unit.

### 3.5 Charging using the mains power unit



1. Plug the mains power unit into the rear side of the device.
2. Plug the mains power unit into the power outlet.
  - » The device will be fully charged.

### 3.6 Connecting/removing the secretion canister TRACHEOFIRST® PRO / TRACHEOPORT® PRO and the hoses

#### 3.6.1 Connecting the TRACHEOFIRST® PRO / TRACHEOPORT® PRO secretion canister

**⚠ WARNING**

**Risk of infection from contaminated bacterial and viral filter as well as canister lid**

Deadly diseases can be transmitted.

- Never operate the device without a bacterial and viral filter. Always keep at least one bacterial and viral filter on hand.
- Wear disposable gloves when changing the bacterial and viral filter and the canister lid.
- Prior to each use, check whether the bacterial and viral filter is dry and clean. Replace the bacterial and viral filter if it is discoloured or soiled, or after oversuction. The bacterial and viral filter must not be dried and not reused.
- Replace the bacterial and viral filter after a patient change. Replace the bacterial and viral filter after two months even if there is no patient change (requirement: device is in use).

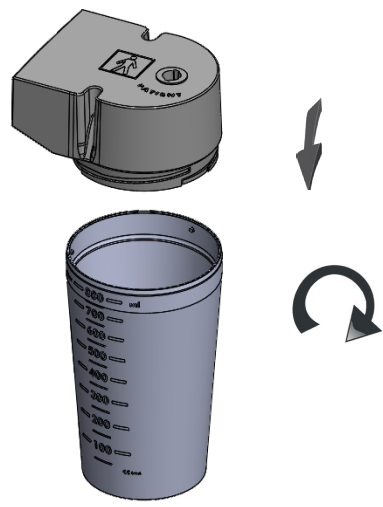
	<p>☞ Recommendation: Before suction, fill some water (approx. 10–20 ml) into the TRACHEOFIRST® PRO / TRACHEOPORT® PRO secretion canister. This will prevent the secretion from drying out.</p> <ol style="list-style-type: none"> <li>1. Check that the black seal is fitted properly in the single-patient canister lid TRACHEOFIRST® PRO / TRACHEOPORT® PRO. If the seal is not in the single-patient canister lid TRACHEOFIRST® PRO / TRACHEOPORT® PRO, insert the seal.</li> <li>2. Place the TRACHEOFIRST® PRO / TRACHEOPORT® PRO canister lid on the TRACHEOFIRST® PRO / TRACHEOPORT® PRO secretion canister.</li> <li>3. Hold the TRACHEOFIRST® PRO / TRACHEOPORT® PRO secretion canister with one hand and screw on the TRACHEOFIRST® PRO / TRACHEOPORT® PRO canister lid by turning it a quarter turn clockwise.</li> </ol>
---	--

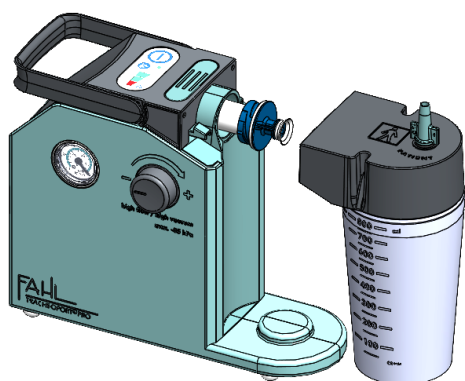
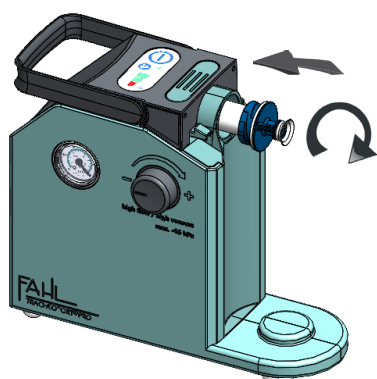

4. Check that the TRACHEOFIRST® PRO / TRACHEOPORT® PRO canister lid is tightly closed.
  5. Check the white seal on the bacterial and viral filter to see whether it is positioned correctly. If the white seal is missing, replace the bacterial and viral filter.
  6. Insert the bacterial and viral filter into the corresponding opening on the device and turn the filter a quarter turn clockwise.
  7. Place the TRACHEOFIRST® PRO / TRACHEOPORT® PRO secretion canister into the canister guides on the base of the device. To lock the TRACHEOFIRST® PRO / TRACHEOPORT® PRO secretion canister in place, push on the lid of the TRACHEOFIRST® PRO / TRACHEOPORT® PRO secretion canister until it engages or keep the turquoise release button pressed while inserting the TRACHEOFIRST® PRO / TRACHEOPORT® PRO secretion canister until it engages.
  8. Make sure that the TRACHEOFIRST® PRO / TRACHEOPORT® PRO secretion canister is firmly in place.
- ☞ The device is ready for use. Connect the hose adapter and the suction hose.

### 3.6.2 Notes on the bacterial and viral filter

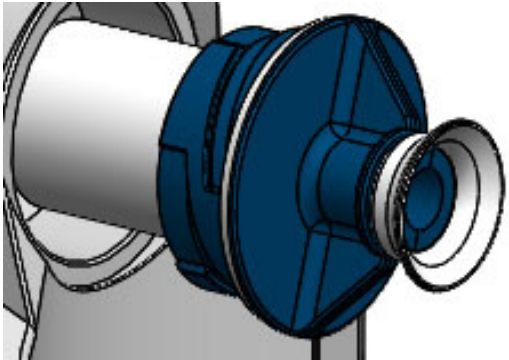
	<ul style="list-style-type: none"> <li>☞ The bacterial and viral filter is located between the device and the TRACHEOFIRST® PRO / TRACHEOPORT® PRO secretion canister. This consists of a hydrophobic bacterial and viral filter with a blue support and white seal. The bacterial and viral filter effectively protects the device from oversuction and contamination.</li> <li>☞ The bacterial and viral filter is designed for use on a single patient. The bacterial and viral filter viral filter has to be replaced after a patient change. If it is used exclusively on the same patient, the bacterial and viral filter must be replaced after two months (requirement: device is in use).</li> <li>☞ Never operate the device without a bacterial and viral filter.</li> </ul>
---	---

### 3.6.3 Removing the bacterial and viral filter

Remove the used bacterial and viral filter if a patient change is about to take place or replace the used bacterial and viral filter every two months when using the device for the same patient (requirement: device is in use).

Wear disposable gloves when changing the bacterial and viral filter.

1. Remove the TRACHEOFIRST® PRO / TRACHEOPORT® PRO secretion canister as instructed in chapter “4.5.1 Removing the TRACHEOFIRST® PRO / TRACHEOPORT® PRO secretion canister” on page 29.
  2. Turn the bacterial and viral filter anti-clockwise and pull the bacterial and viral filter out of the opening.
- ☞ The bacterial and viral filter has been removed.

### 3.6.4 Inserting the bacterial and viral filter

1. Check the white seal on the bacterial and viral filter to see whether it is positioned correctly. If the white seal is missing, replace the bacterial and viral filter.
  2. Insert the new bacterial and viral filter into the corresponding opening on the device and turn the filter a quarter turn clockwise.
- ☞ The device is ready for use again.

### 3.6.5 Connecting the hose adapter

	<ol style="list-style-type: none"> <li>1. Insert the turquoise hose adapter into the opening on the TRACHEOFIRST® PRO / TRACHEOPORT® PRO canister lid.</li> <li>2. Turn the turquoise hose adapter a quarter turn clockwise.</li> <li>3. Now, check that the hose adapter is connected firmly to the TRACHEOFIRST® PRO / TRACHEOPORT® PRO secretion canister.</li> <li>4. Next, connect the suction hose to the turquoise hose adapter.</li> <li>5. Connect the open end of the suction hose to a fingertip.</li> </ol> <p>☞ The device is ready for use.</p>
---	---

### 3.6.6 Holder for suction hose

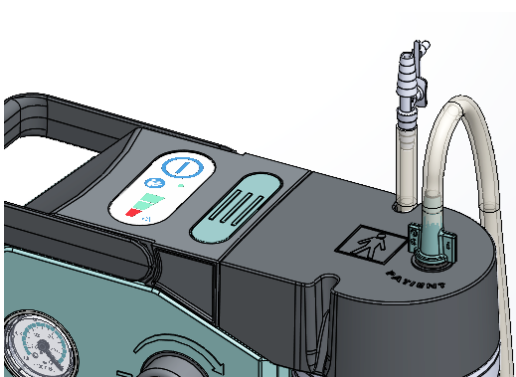
	<ol style="list-style-type: none"> <li>1. Clip the suction hose into the corresponding hose holders on the TRACHEOFIRST® PRO / TRACHEOPORT® PRO canister lid.</li> </ol> <p>☞ The suction hose has been attached in place and is ready for use.</p>
---	---

## 3.7 Connecting the Serres® refitting set

**⚠ WARNING**

**Risk of infection from contaminated secretion canister system and hoses.**

Deadly diseases can be transmitted.

- Only use Serres® suction bags with an integrated bacterial filter.
- Never operate the device without a bacterial and viral filter. Always keep at least one bacterial and viral filter on hand.
- Wear disposable gloves.
- Prior to each use, check whether the bacterial and viral filter is dry and clean. Replace the bacterial and viral filter if it is discoloured or soiled, or after oversuction. The bacterial and viral filter must not be dried and reused.
- Replace the bacterial and viral filter for the Serres® refitting set after four months (requirement: device is in use).
- Only use sterile packaged parts when the packaging is undamaged.

**⚠ WARNING**

**Insufficient or no vacuum due to incorrect connection.**

The patient can suffocate.

- Observe the manufacturer's operating instructions for the Serres® canister system.

**3.7.1 Connection**

1. Attach the support for the Serres® external canister directly to the device.
2. Check the bacterial and viral filter for the Serres® refitting set. The blue connection for the vacuum connection hose must point towards 12 o'clock.

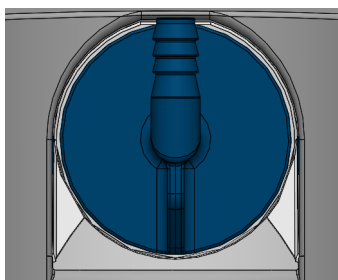

3. Insert the Serres® suction bag into the Serres® external canister. Observe the manufacturer's operating instructions for the disposable canister system. The external canister must be placed on a firm, level surface and must not be connected to the device.
  4. Check whether the foil of the suction bag is fully inserted into the external canister and the lid fits tightly on the external canister.
  5. Insert the Serres® canister system (external canister with suction bag) into the Serres® support for the canister system. The scale on the canister must point towards the device.
  6. Attach the vacuum connection hose to the bacterial and viral filter and to the angle on the Serres® external canister.
  7. Attach the disposable suction hose to the Serres® suction bag.
  8. Close the secondary air opening of the fingertip and close the front opening with your thumb.
  9. Switch on the device so that the pump builds up vacuum.
- ☞ The Serres® suction bag unfolds.

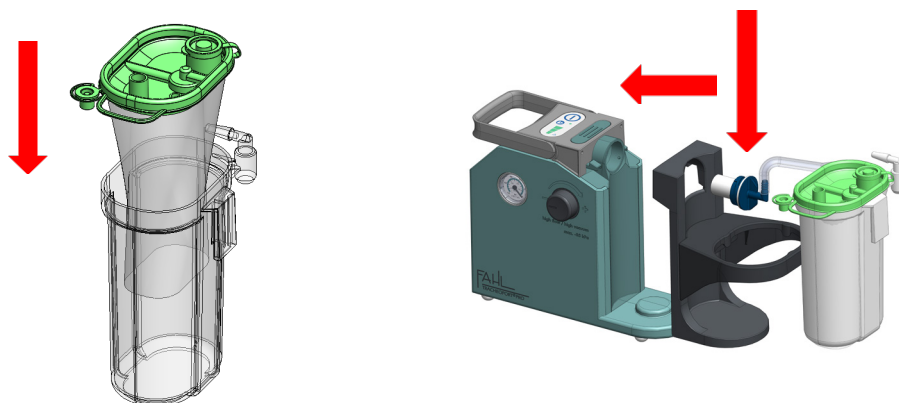



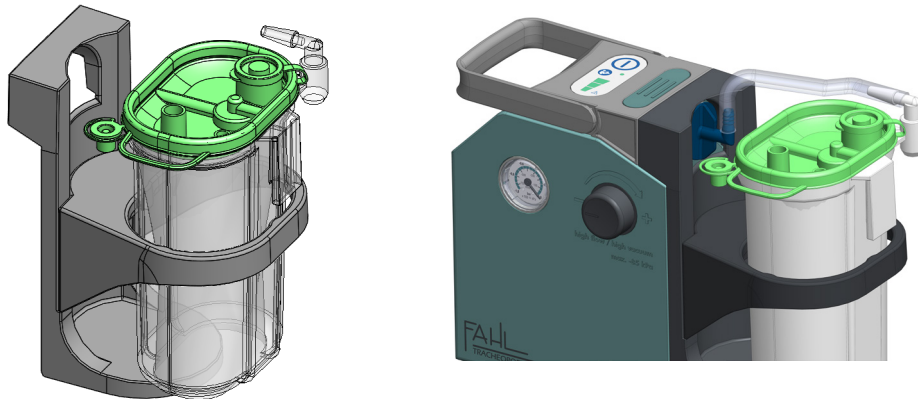

### 3.7.2 Removal

1. Remove the disposable suction hose from the Serres® suction bag.
2. Close the “patient” connection on the Serres® suction bag with the green cap.
3. Remove the vacuum connection hose from the Serres® external canister.
4. Remove the Serres® canister system from the support.
5. Remove the sealed Serres® suction bag from the Serres® external canister and dispose of it.
6. Clean the Serres® external canister according to the manufacturer’s operating instructions.
7. Replace the bacterial and viral filter after four months (requirement: device is in use).

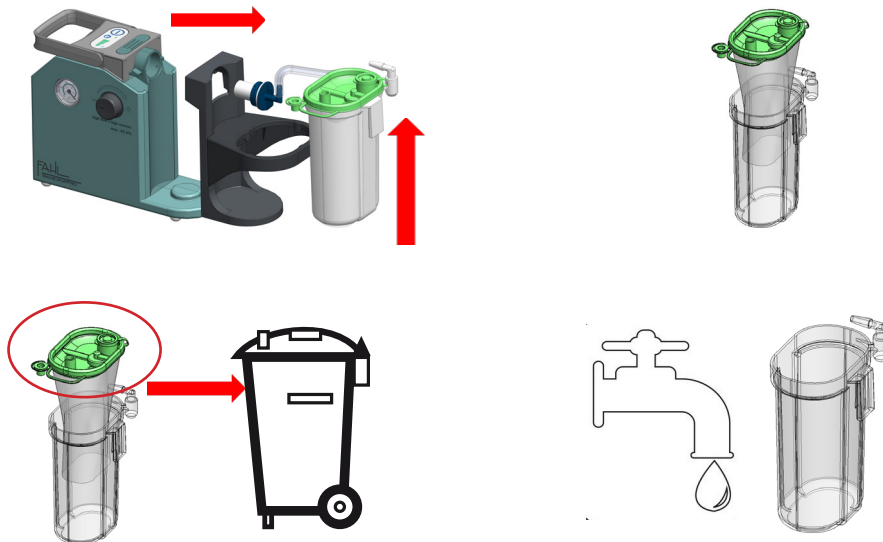

### 3.7.3 Notes on the bacterial and viral filter for the Serres® refitting set

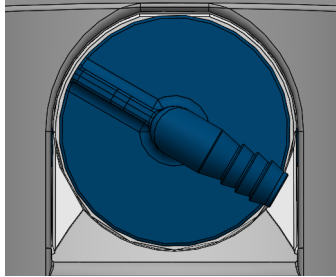

- The bacterial and viral filter is located between the device and the Serres® canister system.
- This consists of a hydrophobic bacterial and viral filter with a blue support and white seal.
- The bacterial and viral filter effectively protects the device from oversuction and contamination.
- ☞ The bacterial and viral filter for the Serres® refitting set must be replaced after four months (requirement: device is in use).
- ☞ Never operate the device without a bacterial and viral filter.

#### **Wear disposable gloves when changing the bacterial and viral filter.**

1. Remove the Serres® canister system.
2. Turn the bacterial and viral filter anti-clockwise and pull the bacterial and viral filter out of the opening.
  - ☞ The bacterial and viral filter has been removed.
3. Insert the new bacterial and viral filter into the corresponding opening on the device and turn the filter a quarter turn clockwise. The blue connection for the vacuum connection hose must point towards 12 o'clock.
  - ☞ The device is immediately ready for use.

## 4.0 Operation

### **⚠ WARNING**

#### **Risk of infection due to lack of hygiene or damaged components!**

Deadly diseases can be transmitted.

- Always use new consumables for every patient (TRACHEOFIRST® PRO / TRACHEO-PORT® PRO secretion canister, bacterial and viral filter, hose adapter, and suction hose).
- Always check whether hoses or the single-patient secretion canister system are damaged before using the device. Replace any damaged parts.

### **⚠ WARNING**

#### **Electric shock from damaged equipment!**

Cardiac arrhythmias may be caused.

- Always check the device and mains power unit for damage before use.
- Replace any damaged parts immediately.
- Do not use the device if it is damaged.

### Ambient conditions during operation

- Temperature: 0...+40°C
- Relative humidity: 20...80%
- Air pressure: 700...1060 hPa

## 4.1 Switching on the device

☞ The device should only be left on for as long as you need it. This will prolong the battery life (of the TRACHEO-PORT® PRO).

1. Press the on/off button to switch on the device.
  - » The pump starts.
  - » The operation status indicator (LED) below the on/off button lights up as long as the device is switched on.

## 4.2 Switching off the device

1. Switch off the device by pressing the on/off button.

## 4.3 Adjusting the vacuum

### **⚠ WARNING**

#### **Excessive vacuum!**

Patient may be seriously injured.

- Observe the valid guidelines.
  - Select the vacuum according to the patient and the application.
  - Using the device on children requires a lower vacuum setting. Observe the instructions issued by the attending physician.
1. Switch on the device.
  2. Set the desired vacuum by closing the suction hose opening and allowing the vacuum to build up.

3. Turn the vacuum regulator to the right until the vacuum gauge shows the desired vacuum.
4. To reduce the desired vacuum, turn the vacuum regulator to the left.
  - ☞ The vacuum regulator shows the setting range directly (from - to +).
  - ☞ You can further fine-tune the vacuum using the vacuum regulator on the fingertip.

## 4.4 Suction

### **⚠ WARNING**

#### **Device failure if the period of continuous operation is too long!**

Patient can suffocate.

- Make sure that the device does not remain switched on for longer than necessary.
- Check the status of the battery regularly while you operate the device.

### **⚠ WARNING**

#### **Risk of infection!**

Deadly diseases can be transmitted.

- Always wear disposable gloves during suction.

### **⚠ CAUTION**

#### **Risk of injury due to inappropriate material or untrained users!**

Injuries to the patient's oral cavity and pharynx could occur.

- Apply particular care when suctioning out the tracheal area.
  - The patient may be seriously injured if the suction capacity used is too high. Select the suction capacity according to the patient and the application. Turn the suction regulator to set the desired strength. The vacuum gauge shows the current pressure.
  - Risk of suffocation when the TRACHEOFIRST® PRO / TRACHEOPORT® PRO secretion canister is full.
  - Pay attention to the filling level of the TRACHEOFIRST® PRO / TRACHEOPORT® PRO secretion canister.
  - Empty the TRACHEOFIRST® PRO / TRACHEOPORT® PRO secretion canister as soon as it is half full. When the secretion canister system is full, you can no longer use the device for suction.
  - Make sure that the hose is not kinked during suction. Otherwise, the suction capacity applied on the patient is too low.
1. Perform suction as instructed by the trained medical staff.
  2. Control the suction process and the desired vacuum using the secondary air opening on the fingertip.
  3. Do not switch off the device until you have finished performing suction.
  4. If there is a mains power unit connected, unplug it from the mains before unplugging it from the device.
  5. Remove the TRACHEOFIRST® PRO / TRACHEOPORT® PRO secretion canister. Observe chapter "4.5.1 Removing the TRACHEOFIRST® PRO / TRACHEOPORT® PRO secretion canister" on page 29.

## 4.5 After use

1. Switch off the device by pressing the on/off button.
2. Clean the device after each use; see chapter "5.0 Cleaning and disinfection" on page 30.
3. Perform a function check after each cleaning; see chapter "6.1 Function check" on page 36.

### 4.5.1 Removing the TRACHEOFIRST® PRO / TRACHEOPORT® PRO secretion canister

1. Remove the TRACHEOFIRST® PRO / TRACHEOPORT® PRO secretion canister by pressing and holding the turquoise release button on the control panel and taking the TRACHEOFIRST® PRO / TRACHEOPORT® PRO secretion canister out to the side.
  2. Open the TRACHEOFIRST® PRO / TRACHEOPORT® PRO canister lid by turning the lid a quarter turn anti-clockwise.
  3. Remove the TRACHEOFIRST® PRO / TRACHEOPORT® PRO canister lid from the TRACHEOFIRST® PRO / TRACHEOPORT® PRO secretion canister.
  4. Clean the device after each use; see chapter "5.0 Cleaning and disinfection" on page 30.
  5. Perform a function check after each cleaning; see chapter "6.1 Function check" on page 36.
- » The device has been made ready for its next use.

### 4.5.2 Removing the suction hose

1. Remove the suction hose from the turquoise hose adapter.
- ☞ You can now remove the suction hose.

### 4.5.3 Removing the hose adapter

1. Remove the suction hose from the turquoise hose adapter.
  2. Turn the turquoise hose adapter a quarter turn anti-clockwise.
  3. Remove the turquoise hose adapter from the TRACHEOFIRST® PRO / TRACHEOPORT® PRO canister lid.
- » You can now remove the hose adapter.

## 5.0 Cleaning and disinfection

### 5.1 Safety instructions for reprocessing

#### 5.1.1 General safety instructions

We recommend that you always document all maintenance work and part replacements in writing.

It is the responsibility of the user to ensure that the demands for cleaning and disinfection are adhered to. Validation and routine monitoring of the procedure will generally be necessary.

The reprocessing treatment may only be carried out by persons who have the necessary expertise. To carry out these measures, the person must have the necessary devices.

#### 5.1.2 Danger for users, patients, and third parties

##### **Risk of infection due to unsuitable accessories!**

Deadly diseases can be transmitted.

- Always wear your own personal protective equipment. The protective equipment consists of protective gloves, protective clothing, goggles, and mouth and nose protection for all steps in which the product components are still contaminated.
- Only use accessories that can be easily reprocessed or ones that are disposable products.

##### **Risk of infection due to unsuitable reprocessing!**

Deadly diseases can be transmitted.

- Make sure that all areas of the accessories can be easily reached.
- Only use suitable load carriers for mechanical reprocessing. This especially applies to accessories with difficult to access cavities and lumens.
- Make sure that air bubbles do not form in the cavities and lumens when placed in the treatment solution.

#### 5.1.3 Avoiding damage to the device

##### **Damage to the device due to improper cleaning!**

The device may become damaged.

- Use a damp cloth, never a wet one, to clean and disinfect the surface of the device.
- Do not use spray disinfectant directly on the device. Spray the disinfectant onto a cloth before disinfecting the surface of the device.
- Ensure that no disinfectant enters the device.
- Make sure that the product is switched off during cleaning.
- The product should never be autoclaved, rinsed under running water, or immersed into any liquids.

**Damage to the device due to cleaning with fixatives!**

Soiling will become permanently unremovable.

- Do not use aldehydes before and for cleaning.
- Do not expose the product to temperatures above 40 °C / 104 °F before and during cleaning.

**Unsuitable accessories!**

The product may become damaged.

- Only use lint-free, soft cloths.
- For final rinsing, always use fully demineralised water.
- Observe the respective operating instructions of all the accessories and devices used.

**Unsuitable cleaning agents and disinfectants.**

The product may become damaged.

- Do not use any process chemicals that contain the following ingredients **on plastic parts**:
  - Chloramide or phenol derivatives
- Do not use any process chemicals that contain the following ingredients **on stainless steel**:
  - Organic or inorganic bases
  - Alkaline solutions
- Do not use any process chemicals that contain the following ingredients **on padding**:
  - Polish or wax polish
  - Chemical cleaning agents
  - Oils, greases, or alcohol

**Incorrect mechanical cleaning and disinfection.**

Corrosion due to moisture.

- When the programme is finished, remove the products immediately.

## 5.2 Preparing/completing reprocessing

### Prior to reprocessing

1. Switch off the device.
2. Disassemble the product for reprocessing in the following order:
  - Remove the mains power unit from the device.
  - Remove the TRACHEOFIRST® PRO / TRACHEOPORT® PRO secretion canister from the device.
  - Carefully remove the TRACHEOFIRST® PRO / TRACHEOPORT® PRO canister lid.
  - Dispose of the secretion.

### After reprocessing

1. Perform a function check.

## 5.3 Prepare surfaces

### 5.3.1 Overview

Surface	After each application	After a patient change	Daily	Weekly	Every two months	Monthly	Pre-cleaning	Wipe cleaning	Wipe disinfection	Spray disinfection	Remarks
Housing incl. carry handle		x		x				x	x		As per agent manufacturer's instructions
Vacuum gauge		x		x				x	x		As per agent manufacturer's instructions
Vacuum regulator		x		x				x	x		As per agent manufacturer's instructions
Release button		x		x				x	x		As per agent manufacturer's instructions
Control panel		x		x				x	x		As per agent manufacturer's instructions

### 5.3.2 Selecting process chemicals

Observe the process chemical manufacturer's specifications.

If heavily soiled, clean the device surface directly with a cloth moistened with clean water.

Agent (manufacturer)	Active ingredients in 100 g	Art	Housing incl. carry handle	Vacuum gauge	Vacuum regulator	Release button	Control panel
<b>Cleaning</b>							
Mikrozid® Sensitive Wipes (Schülke & Mayr)	Benzyl-C12-16-alkyldimethyl-chloride 0.26 g / 100 g C12-14-alkyl[(ethyl phenyl) methyl]dimethyl, chloride 0.26 g / 100 g Didecyldimethylammoniumchloride 0.26 g / 100 g	Wipes	x	x	x	x	x
<b>Disinfection</b>							
Green & Clean SK (Metasys)	Propane-2-ol [67-63-0], didecyl-dimethyl-ammonium-chloride [7173-51-5], C12-14-alkyl [(ethyl-phenyl) methyl] dimethyl-ammonium-chloride [85409-23-0], Benzyl-C12-16-alkyl-dimethyl-ammonium-chloride [68424-85-1]	Foam Ready for use	x	x	x	x	x
Bacillo® 30 Foam (Bode Chemie)	Ethanol 14 g / 100 g, propane-2-ol 10 g / 100 g, propane-1-ol 6 g / 100 g, N-alkyl-amino-propylglycin 0.5 g / 100 g	Foam	x	x	x	x	x
mikrozid® sensitive wipes (Schülke & Mayr)	0.26 g alkyl(C12-16)dimethylbenzylammonium chloride, 0.26 g didecyldimethylammonium chloride, 0.26 g alkyl(C12-14)ethylbenzylammonium chloride	Wipes	x	x	x	x	x



Agent (manufacturer)	Active ingredients in 100 g	Art	Housing incl. carry handle	Vacuum gauge	Vacuum regulator	Release button	Control panel
mikrozid® universal wipes (Schülke & Mayr)	2-propanol 17.4 % / 100 g Ethanol 12.6 % / 100 g	Wipes	x	x	x	x	x
Bacillo® AF (Bode Chemie)	Alcohols	Solution Ready for use	x	x	x	x	x

### 5.3.3 Pre-cleaning

1. Disconnect the device from the mains power supply.
2. Clean the surface evenly with a suitable cloth. Pay particular attention to hard-to-reach areas.
3. Remove the hose adapter and suction hose and rinse them with water at a sink.
  - » No more soiling is visible.

### 5.3.4 Wipe cleaning

1. Disconnect the device from the mains power supply.
2. Clean the surface evenly with a suitable cloth and suitable cleaning agent; see chapter "5.3.1 Overview" on page 32. Pay particular attention to hard-to-reach areas. Use a damp cloth, never a wet one, to clean and disinfect the surface of the device.
  - » No more soiling is visible.

### 5.3.5 Wipe disinfection

1. Disinfect the surface evenly with a suitable cloth and suitable disinfectant. Pay particular attention to hard-to-reach areas. Do not use spray disinfectant directly on the device. Use a damp cloth, never a wet one, to clean and disinfect the surface of the device.
2. Wait for the specified exposure time to elapse.
3. Allow the surface to dry.

## 5.4 Reprocessing the accessories

### 5.4.1 Replacing accessories

Accessories	After each application	After a patient change	Daily	Weekly	Every two months	Monthly	Every four months
TRACHEOFIRST® PRO / TRACHEOPORT® PRO secretion canister		X					
Suction hose with fingertip		X				X	
Hose adapter		X					X
Bacterial and viral filter		X			X		

When the device is to be used on another patient, the bacterial and viral filter, the suction hose, the hose adapter as well as the TRACHEOFIRST® PRO / TRACHEOPORT® PRO secretion canister must be replaced.

#### TRACHEOFIRST® PRO / TRACHEOPORT® PRO secretion canister

- Empty the TRACHEOFIRST® PRO / TRACHEOPORT® PRO secretion canister at least once a day and rinse it thoroughly with clean water. If possible, clean it using a mild household detergent and then rinse it off with clean water.
- ☞ **Recommendation:**  
Before suctioning, fill some water (approx. 10–20 ml) into the TRACHEOFIRST® PRO / TRACHEOPORT® PRO secretion canister. This will prevent the secretion from drying out. The TRACHEOFIRST® PRO / TRACHEOPORT® PRO secretion canister can be boiled (max. number of cycles: 30)
- The TRACHEOFIRST® PRO / TRACHEOPORT® PRO secretion canister is dishwasher safe.
- When the device is to be used on another patient, the TRACHEOFIRST® PRO / TRACHEOPORT® PRO secretion canister must be replaced.
- If the TRACHEOFIRST® PRO / TRACHEOPORT® PRO secretion canister shows signs of damage or leakage, it must be replaced.
- Check the seal in the single-patient canister lid TRACHEOFIRST® PRO / TRACHEOPORT® PRO for dirt or damage. Clean the seal or replace it.
- Check that the black seal is fitted properly in the single-patient canister lid TRACHEOFIRST® PRO / TRACHEOPORT® PRO after cleaning. If the seal is not in the single-patient canister lid TRACHEOFIRST® PRO / TRACHEOPORT® PRO, insert the seal.

#### Serres® refitting set

- Observe the directions in the operating instructions for the secretion canister system.
- Never operate the device without a bacterial and viral filter.

## Suction hose

To prevent secretion from drying out, the suction hose must be rinsed with clean water after every suction process. The water from a rinsing canister can be suctioned through the fingertip into the secretion canister by means of the suction device. Please fill the secretion canister only about halfway.

- We also recommend disinfection, at least once a day, using a recommended disinfectant; see page 32. Observe the respective detergent's instructions for use! Alternatively, thermal disinfection can also be carried out. Observe the instructions in chapter "5.0 Cleaning and disinfection" on page 30.
- It is advisable to hang up the suction hose to dry it.
- Frequent cleaning/disinfection can cause the suction hose to discolour and the material to become brittle. Therefore, we recommend a change every 4 weeks at the latest.

## Hose adapter

- Rinse the hose adapter with clean water after every suction process.
- When using the device on the same patient, replace the hose adapter every 4 months.
- If the hose adapter is heavily soiled with clogged or encrusted secretion, it must be replaced immediately.
- When there is a change of patient, the hose adapter must be replaced.

## Bacterial and viral filter

- Never wash or autoclave the bacterial and viral filter.
- The bacterial and viral filter cannot be detached from the filter cartridge.
- Disposable article; for use with a single patient only.
- The bacterial and viral filter must be replaced after a patient change.
- When using the device on the same patient, replace the bacterial and viral filter every two months (requirement: device is in use).
- Replace the bacterial and viral filter if it is discoloured or soiled, or after oversuction.

## Bacterial and viral filter for the Serres® refitting set

- Never wash or autoclave the bacterial and viral filter.
- The bacterial and viral filter cannot be detached from the filter cartridge.
- The bacterial and viral filter must be replaced after four months (requirement: device is in use).
- Replace the bacterial and viral filter if it is discoloured or soiled, or after oversuction.

## 6.0 Maintenance and service

Repairs may only be carried out by persons who have the appropriate technical knowledge and are familiar with the product. The person in question must possess the necessary test devices and original spare parts required to carry out these measures.

The unit may only be used if it is free of defects. Furthermore, there are no manufacturer specifications for maintenance. In the commercial sector, regular inspections may be required as part of accident prevention regulations at the workplace. For portable electrical devices, these tests must be carried out at least every 24 months. The relevant employers' liability insurance associations can provide information on this.

### Periodic tests

Comply with the country-specific guidelines regarding regular testing, especially with regard to electrical safety. Andreas Fahl Medizintechnik Vertrieb GmbH recommends performing a test every 24 months in accordance with the Medical Devices Operator Ordinance.

### 6.1 Function check

Perform a function check:

- Prior to each use.
- After each use and after cleaning.
- Every 4 weeks if the device is not being used.
- After any maintenance work, servicing, or repair.

### 6.2 Sending in the device

- Remove all consumables and dispose of them properly.
- Clean and disinfect the product and accessories in accordance with the operating instructions.
- Place any used accessories with the product.
- The device must be well padded and packed in suitable packaging.
- Send in the device for repair via the dealer from whom you purchased the device.

### 6.3 Handling batteries

The battery in the TRACHEOPORT® PRO is a wear part and is therefore excluded from the general warranty. There is a function guarantee of 6 months.

Please observe the following notes in order to reach the maximum service life of your battery:

- Only use the original battery.
- Prior to first use, the battery must be fully charged.
- Battery-run devices should only be stored when they are charged.
- Fully charge the battery every 3 months, even if the device is not used.
- Do not expose the battery to direct solar radiation and keep them away from radiators. The ideal storage temperature for the battery is between 8 and 15 °C.
- Exchange the battery when the remaining battery service life noticeably decreases.
- Batteries are run-down after approx. 400 charging cycles.

## 7.0 Troubleshooting

The TRACHEOFIRST® PRO or the TRACHEOPORT® PRO has been subjected to thorough quality control in the factory. Nevertheless, if a problem does occur, you can possibly resolve it yourself.

### Recharging and battery status

Error symptom	Possible cause	Remedy
Device cannot be recharged.	The mains power unit's plug is not plugged in properly.	Check the connection to the mains supply.
	The mains power unit is defective.	Replace the mains power unit.
	Battery is not connected properly.	Send the device in for repair.
	Battery temperature is too high or too low.	After prolonged use: Let the device cool down. Extreme ambient temperature: If necessary, move the device to a cooler or warmer location.
	Defective battery.	Exchange the battery. Send the device in for repair.
	Defective fuse or electronics.	Send the device in for repair.
When recharging the battery, 100% cannot be achieved. The charging time can take up to 12 hours.	Battery service life is exhausted or the battery is defective.	Send the device in for repair.
	Wrong mains power unit.	Only use the mains power unit originally included or an original spare part.
Red LED of the battery status indicator is lit up although the battery is fully charged.	Defective battery.	Send the device in for repair.

### Switching on and off

Error symptom	Possible cause	Remedy
Device cannot be switched on or off.	Battery is discharged.	Recharge the battery.
	Battery is not connected properly.	Send the device in for repair.
	The plug from the charging accessories is poorly fitted.	Send the device in for repair.
	Defective fuse or electronics.	Send the device in for repair.
Pump does not start up.	Vacuum is already built up.	Do not switch on the device if the vacuum is already built up.

## Vacuum and suction capacity

Error symptom	Possible cause	Remedy
Vacuum is not built up or cannot be reached.	Battery is discharged or defective.	Charge the battery or send the device in for repair.
	Hoses or TRACHEOFIRST® PRO / TRACHEOPORT® PRO canister lid are leaking.	<p>Check the TRACHEOFIRST® PRO / TRACHEOPORT® PRO canister lid and the hoses for tight fit.</p> <p>Screw in the bacterial and viral filter tightly. Check the white seal on the bacterial and viral filter.</p> <p>Check that the black seal is fitted properly in the single-patient canister lid TRACHEOFIRST® PRO / TRACHEOPORT® PRO. If there is no seal in the single-patient canister lid TRACHEOFIRST® PRO / TRACHEOPORT® PRO, insert the seal.</p> <p>Check the seal in the single-patient canister lid TRACHEOFIRST® PRO / TRACHEOPORT® PRO for dirt or damage. Clean the seal or replace it.</p>
	Liquid has penetrated the device.	Send the device in for repair.
	Pump is defective or the device has a leak.	Send the device in for repair.
	The disposable suction bag is not inserted correctly or not properly connected.	Check that the disposable suction bag is firmly fitted in the external canister. Check all the connection points on the secretion canister system.
Low suction capacity although the vacuum has been reached.	Hydrophobic bacterial and viral filter is blocked.	Replace the hydrophobic bacterial and viral filter.
	Hose is kinked.	Check the hoses.
	The bacterial filter in the disposable suction bag is blocked.	Replace the suction bag.

## 8.0 Accessories and consumables

### 8.1 Accessories

Name	REF
Refitting set Serres® with external canister for TRACHEOFIRST® PRO / TRACHEOPORT® PRO	65962
Mains power unit	011.1363.0

### 8.2 Consumables

Name	REF
TRACHFLOW® LINE PRO 1.3 m	60506
TRACHEOFIRST® PRO / TRACHEOPORT® PRO bacterial and viral filter	60840
TRACHEOFIRST® PRO / TRACHEOPORT® PRO bacterial and viral filter for Serres® refitting set	60850
Hose adapter	60530
TRACHEOFIRST® PRO / TRACHEOPORT® PRO secretion canister	60630
Fingertip, at least 1 pack = 10 pcs.	60700
Serres® disposable suction bag 1 l with gelling agent, 32 pcs.	57557

## 9.0 Disposal/recycling

### Packaging

4. Recycle any device packaging you no longer need.

### Canister system

Disposable products may not be reprocessed and may not be reused! Please dispose of disposable products professionally.

The following notes are only applicable for reusable products.

1. Clean and disinfect the reusable products of the canister system.
2. Recycle the disinfected reusable products.

### TRACHEOFIRST® PRO and TRACHEOPORT® PRO

Do not dispose of devices or batteries in domestic waste.

1. Clean and disinfect the device.
2. In Germany: Send the product back to Andreas Fahl Medizintechnik-Vertrieb GmbH or your specialist dealer. They will dispose of the device professionally.
3. For other countries: Dispose of the product properly and in accordance with country-specific laws and regulations.



### 9.1 Expected service life

When the device (TRACHEOFIRST® PRO or TRACHEOPORT® PRO) is operated according to the operating instructions, it has an expected service life of 3 years. Regular thorough cleaning and disinfection of the device and the applied parts as well as operation of the suction device in line with the operating instructions are assumed.



## 10.0 Technical data

### 10.1 TRACHEOFIRST® PRO



Input voltage	100 – 240 V~ ± 10 %; 50/60 Hz (13,4 VDC mains power unit)
Current consumption	Max. 1 A
Power consumption	Max. 37 W
Mains power unit	Manufacturer: GlobTek, Inc. Model: GTM46402-3713.4
Suction capacity (on pump, during mains operation at 21°C/1013 hPa)	27 l/min ± 3 l/min
Maximum achievable vacuum at sea level*	-80 kPa ± 5 kPa (-800 mbar ± 50 mbar; -600 mmHg ± 37.5 mmHg) or 80% of the daily air pressure
Vacuum display	-1...0 bar (±2,5% of the final value) (mmHg, bar, kPa)
Vacuum adjustment	Infinitely variable vacuum adjustment
Mode of operation	Interval operation (max. 30 minutes "ON"; min 30 minutes "OFF")
Noise level	< 65 dB (A) @1 m
Environmental conditions: Transport/ storage	
- Temperature range	-30...+70°C
- Humidity without condensation	5...90 %
- Air pressure	700...1060 hPa
Ambient conditions for operation	
- Temperature	0...+40°C
- Humidity without condensation	20...80 %
- Air pressure	700...1060 hPa
Maximum operational altitude	3000 m (NN)
Contamination level	Class 2
Overvoltage category	II
Dimensions (W x H x D)	286 x 243 x 118 mm (with secretion canister) 340 x 253 x 140 mm (with Serres® refitting set)
Weight	1,9 kg (with empty secretion canister) 2,1 kg (with empty Serres® refitting set)
Protection class against electric shock (according to EN 60601-1)	II
Classification of applied parts	Application parts type BF 
Degree of protection	IP21

CE mark	 <b>0124</b>
ID No. (REF)	67800 TRACHEOFIRST® PRO

\* Data may differ depending on elevation above sea level, prevalent air pressure and air temperature.

## 10.2 TRACHEOPORT® PRO

Voltage	100 - 240 V~ ± 10%; 50/60 Hz (13.4 VDC mains power unit)
Current consumption	Max. 1 A
Power consumption	Max. 37 W
Mains power unit	Manufacturer: GlobTek, Inc. Model: GTM46402-3713.4
Other power sources	12 V; 4 Ah, lead acid battery Minimum 400 recharging cycles within approx. 3 years
Battery capacity	Ca. 60 minutes
Charging time	50% in 3 h Fully charged in 12 h
Suction capacity (on pump, during mains operation at 21°C/1013 hPa)	27 l/min ± 3 l/min
Maximum achievable vacuum at sea level*	-80 kPa ± 5 kPa (-800 mbar ± -50 mbar; -600 mmHg ± 37.5 mmHg) or 80% daytime barometric pressure
Vacuum display	-1 to 0 bar (± 2.5% of final value) (mmHg, bar, kPa)
Vacuum adjustment	Infinitely variable vacuum adjustment
Backup mode	If battery is exhaustively discharged, device can be operated on mains power
Operating time	Interval operation (max. 30 minutes ON; min. 30 minutes OFF)
Noise level	< 65 dB (A) @ 1 m
Environmental conditions: Transport/ storage	
- Temperature range	-30...+70 °C
- Humidity without condensation	5...90%
- Air pressure	700...1060 hPa
Ambient conditions for operation	
- Temperature	0...+40 °C
- Humidity without condensation	20...80%
- Air pressure	700...1060 hPa
Maximum operational altitude	3000 m (NN)
Contamination level	Class 2
Overvoltage category	II

Dimensions WxHxD	286 x 243 x 118 mm (with secretion canister) 340 x 253 x 140 mm (with Serres® refitting set)
Weight	3,3 kg (with empty secretion canister) 3,5 kg (with empty Serres® refitting set)
Protection class against electric shock (according to EN 60601-1)	II
Classification of applied parts	Application parts type BF 
Degree of protection	IP 21
CE mark	
ID No. (REF)	63900 TRACHEOPORT® PRO

\* Data may differ depending on elevation above sea level, prevalent air pressure and air temperature.

### 10.3 Bacterial and viral filter

Degree of separation against bacteria	99.999778%*
Degree of separation against viruses	99.73%*
Total degree of separation	>99.95%*
Filter class	H13 (High-Efficiency Particulate Air/Arrestance)*

\*External test report (test laboratory)

## 11.0 Notes on EMC

- Medical electrical equipment is subject to special precautions with regard to EMC and must be installed according to the following EMC notes.

### Guidance and manufacturer's declaration – ambient conditions

The TRACHEOFIRST® PRO and the TRACHEOPORT® PRO are suitable for operation in the following environments:

- Homecare in any building.

The customer or user of the device must ensure that it is used in a prescribed environment.

### Guidance and manufacturer's declaration – key features

- Please note the technical data in these instructions. The essential features are fully usable even in the presence of electromagnetic disturbances.

### Guidance and manufacturer's declaration – electrical components

The TRACHEOFIRST® PRO and the TRACHEOPORT® PRO feature the following electrical components:

Type	REF	Max. cable length
Mains power unit	011.1363.0	1.2 m

### Guidance and manufacturer's declaration – warnings

#### Warning

The use of electrical components and accessories other than those specified or provided by the manufacturer may cause increased electromagnetic interference or reduced immunity to electromagnetic interference and result in faulty operation of the device.

#### Warning

Portable RF communications equipment (e.g., radios, antenna cables) should be used no closer than 30 cm\* to any part of the product, including cables, as specified by the manufacturer. Otherwise, degradation of the performance of this equipment could result.

- \* At higher immunity test levels the distance may be reduced.

#### Warning

Avoid placing the device on top of or next to another device. This could otherwise result in faulty operation. If such placement cannot be avoided, the proper functioning of the device must be monitored regularly. If possible, please switch off any nearby devices that are not in use.

## 12.0 Legal notice

The manufacturer assumes no liability for functional failures, injuries, infections, and/or other complications or other undesirable incidents resulting from unauthorised product modifications or improper use, care, and/or handling.

In particular, the manufacturer assumes no liability for damage caused by modifications or repairs to the device if these modifications or repairs were not carried out by the manufacturer or an authorised service centre. This applies both to damage caused to the device itself and to all consequential damage resulting from this.

In the event of use, application, care (cleaning, disinfection), or storage of the device contrary to the specifications in these operating instructions, the manufacturer is exempt from any liability, including liability for defects, to the extent permitted by law.

Should a serious incident occur in connection with this product, it must be reported to the manufacturer and the competent authority of the Member State in which the user and/or patient is domiciled.

The sale and delivery of all products shall take place exclusively in accordance with the General Terms and Conditions (GTCs) of Andreas Fahl Medizintechnik-Vertrieb GmbH; these can be obtained directly from Andreas Fahl Medizintechnik-Vertrieb GmbH.

The manufacturer reserves the right to make product modifications at any time.

TRACHEOFIRST® and TRACHEOPORT® are registered trademarks of Andreas Fahl Medizintechnik-Vertrieb GmbH, Cologne, Germany.



 Andreas Fahl  
Medizintechnik-Vertrieb GmbH  
August-Horch-Str. 4a  
51149 Köln - Germany  
Phone +49 (0) 22 03 / 29 80-0  
Fax +49 (0) 22 03 / 29 80-100  
vertrieb@fahl.de  
www.fahl.com



**MedizinTechnik**

 ATMOS MedizinTechnik GmbH & Co. KG  
Ludwig-Kegel-Str. 16  
79853 Lenzkirch / Germany