

# LARYVOX® INSERTER UNIEK PRO

REF 25930



- ▶ **LARYVOX® INSERTER UNIEK PRO** består av ett placeringsinstrument och en applikator. Används för optimal anterograd placering eller byte av en **LARYVOX® UNIEK** talventil.
- ▶ Placeringsinstrumentet har en fixeringsmöjlighet för säker placering av talventilen.
- ▶ Applikatorn gör det lätt att föra in en talventil, och den är klar att använda efter några få steg.
- ▶ Den avrundade applikatorspetsen underlättar dessutom en skonsam placering och gör talventilbytet så bekvämt som möjligt.

## LEVERANS

### LARYVOX® INSERTER UNIEK PRO REF 25930

- 1 st. placeringsinstrument (vitt)
- 1 st. applikator
- 1 st. adapter
- 1 st. glidgel
- 1 st. bruksanvisning

Den här införaren används uteslutande i samband med **LARYVOX® UNIEK**.

Röstventil medföljer inte leveransen utan måste beställas separat. Följ bruksanvisningen för talventilen!

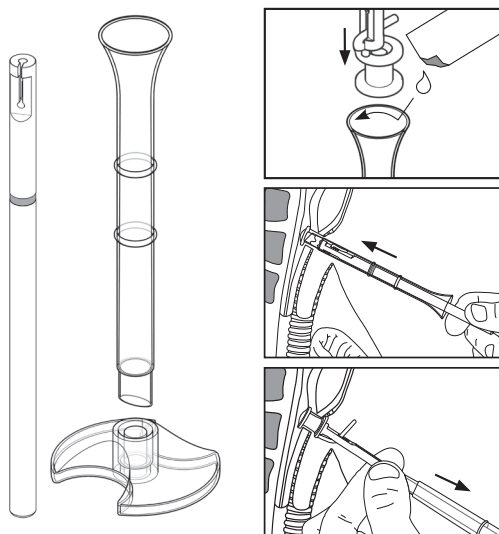

Produkt

LARYVOX® INSERTER UNIEK PRO

PU

1 styck

REF























25930

























## LARYVOX® INSERTER

## TILLDELNING

25900	25910	25915	25920	25925 25930
LARYVOX® INSERTER	LARYVOX® INSERTER EXPERT	LARYVOX® INSERTER EXPERT SMALL	LARYVOX® INSERTER SPECIAL	LARYVOX® INSERTER UNIEK
Färb				
				
				

Kontrollera i förväg längden (xx) på den röstventil som ska sättas in.

REF	Beteckning röstprotes	Längd	INSERTER
20 FRENCH			
AD20xx-NS	ADVANTAGE Indwelling 20 Fr. Voice Prosthesis	06-14 mm	
AD2004-NS	ADVANTAGE Indwelling 20 Fr. Voice Prosthesis	04 mm	
AS20xx-NS	ADVANTAGE Indwelling 20 Fr. Voice Prosthesis	06-14 mm	
AS2004-NS	ADVANTAGE Indwelling 20 Fr. Voice Prosthesis	04 mm	
DV20xx-LF	DUAL VALVE Indwelling LF 20 Fr. Voice Prosthesis	06-14 mm	
DV20xx-NS	DUAL VALVE Indwelling 20 Fr. Voice Prosthesis	06-14 mm	
IN2004-NS	CLASSIC Indwelling 4 mm 20 Fr. Voice Prosthesis	04 mm	
IN20xx-NS	CLASSIC Indwelling 20 Fr. Voice Prosthesis	06-20 mm	
IN2004-LEF	CLASSIC Indwelling LEF 4 mm 20 Fr. Voice Prosthesis	04 mm	
IN20xx-LEF	CLASSIC Indwelling LEF 20 Fr. Voice Prosthesis	06-14 mm	
IN20xx-IR	CLASSIC Indwelling IR 20 Fr. Voice Prosthesis	06-12 mm	
IN2004-LEIR	CLASSIC Indwelling LEIR 20 Fr. 4 mm Voice Prosthesis	04 mm	
IN20xx-LEIR	CLASSIC Indwelling LEIR 20 Fr. Voice Prosthesis	06-08 mm	
IN20xx-LESL	CLASSIC Indwelling LESL 20 Fr. Voice Prosthesis	05 und 07 mm	
IN2004-LETO	TEP Occluder Indw. LETO 20 Fr. 4 mm Voice Prosthesis	04 mm	
IN20xx-LETO	TEP Occluder Indw. LETO 20 Fr. Voice Prosthesis	06-14 mm	
IN2004-LF	CLASSIC Indwelling LF 20 Fr. 4 mm Voice Prosthesis	04 mm	
IN20xx-LF	CLASSIC Indwelling LF 20 Fr. Voice Prosthesis	06-14 mm	
IN20xx-SL	CLASSIC Indwelling SL 20 Fr. Voice Prosthesis	05,07 und 09 mm	
IN20xx-SO	CLASSIC Indwelling STERIL 20 Fr. Voice Prosthesis	08-14 mm	
25010-xx	LARYVOX® Uniek U.L.R. 21 Fr.	05-13 mm	
25020-xx	LARYVOX® Uniek U.L.R. 24 Fr.	05-13 mm	

REF	Beteckning röstprotes	Längd	INSERTER
16 FRENCH			
AS1604-NS	ADVANTAGE Indwelling 16 Fr. Voice Prosthesis	04 mm	
AS16xx-NS	ADVANTAGE Indwelling 16 Fr. Voice Prosthesis	06-14 mm	
IN1604-NS	CLASSIC Indwelling 4 mm 16 Fr. Voice Prosthesis	04 mm	
IN16xx-NS	CLASSIC Indwelling 6 mm 16 Fr. Voice Prosthesis	06-20 mm	
IN16xx-SO	CLASSIC Indwelling STERIL 10 mm 16 Fr. Voice Prosthesis	08-14 mm	
IN16xx-IR	CLASSIC Indwelling IR 16 Fr. Voice Prosthesis	06-12 mm	
IN1604-LEF	CLASSIC Indwelling LEF 4 mm 16 Fr. Voice Prosthesis	04 mm	
IN16xx-LEF	CLASSIC Indwelling LEF 16 Fr. Voice Prosthesis	06-14 mm	
IN16xx-LESL	CLASSIC Indwelling LESL 16 Fr. Voice Prosthesis	05 und 07 mm	
IN1604-LETO	CLASSIC Indwelling LETO 4 mm 16 Fr. Voice Prosthesis	04 mm	
IN16xx-LETO	CLASSIC Indwelling LETO 16 Fr. Voice Prosthesis	06-14 mm	
IN1604-LF	CLASSIC Indwelling LF 4 mm 16 Fr. Voice Prosthesis	04 mm	
IN16xx-LF	CLASSIC Indwelling LF 16 Fr. Voice Prosthesis	06-14 mm	
IN16xx-SL	CLASSIC Indwelling SL 16 Fr. Voice Prosthesis	05,07 und 09 mm	
IN16xx-SO	CLASSIC Indwelling STERIL 16 Fr. Voice Prosthesis	08-14 mm	
Insättning med gelkapselteknik			
IN20xx-NS	CLASSIC Indwelling 20 Fr. Voice Prosthesis	06-20 mm	
AD20xx-NS	ADVANTAGE Indwelling 20 Fr. Voice Prosthesis	06-14 mm	
AS20xx-NS	ADVANTAGE Indwelling 20 Fr. Voice Prosthesis	06-14 mm	
IN20xx-LF	CLASSIC Indwelling LF 20 Fr. Voice Prosthesis	06-14 mm	
IN20xx-LEF	CLASSIC Indwelling LEF 20 Fr. Voice Prosthesis	06-14 mm	
IN20xx-SL	CLASSIC Indwelling SL 20 Fr. Voice Prosthesis	05,07 und 09 mm	
IN20xx-LEIR	CLASSIC Indwelling LEIR 20 Fr. Voice Prosthesis	05 und 07 mm	
IN20xx-LESL	CLASSIC Indwelling LESL 20 Fr. Voice Prosthesis	05 und 07 mm	
IN20xx-IR	CLASSIC Indwelling IR 20 Fr. Voice Prosthesis	06-12 mm	
IN20xx-LETO	TEP Occluder Indw. LETO 20 Fr. Voice Prosthesis	06-14 mm	



Andreas Fahl Medizintechnik-Vertrieb GmbH är exklusiv försäljningspartner för Blom-Singer®-produkter i utvalda europeiska länder. Blom-Singer® är ett registrerat varumärke som tillhör Freudenberg Medical, LLC.