

**LARYVOX® INSERTER UNIEK PRO**

REF 25930



- ▶ Der **LARYVOX® INSERTER UNIEK PRO** besteht aus einem Platzierungsinstrument sowie einem Applikator. Er dient einer optimalen anterograden Platzierung bzw. dem Wechsel einer **LARYVOX® UNIEK** Stimmprothese
- ▶ Das Platzierungsinstrument verfügt über eine Fixierungsmöglichkeit um die Stimmprothese sicher zu platzieren
- ▶ Der Applikator ermöglicht ein müheloses Einführen der Stimmprothese und ist in wenigen Schritten vorbereitet
- ▶ Die abgerundete Applikator-Spitze fördert zudem eine sanfte Platzierung und macht den Stimmprothesen-Wechsel so angenehm wie möglich

**LIEFERUMFANG****LARYVOX® INSERTER UNIEK PRO REF 25930**

- 1 x Platzierungsinstrument (weiß)
- 1 x Applikator
- 1 x Adapter
- 1 x Gleitgel
- 1 x Gebrauchsanweisung

Dieser Inserter wird ausschließlich im Zusammenhang mit der **LARYVOX® UNIEK** angewandt.

Die Stimmprothese ist nicht im Lieferumfang enthalten und muss separat bestellt werden. Bitte die Gebrauchsanleitung der Stimmprothese beachten!

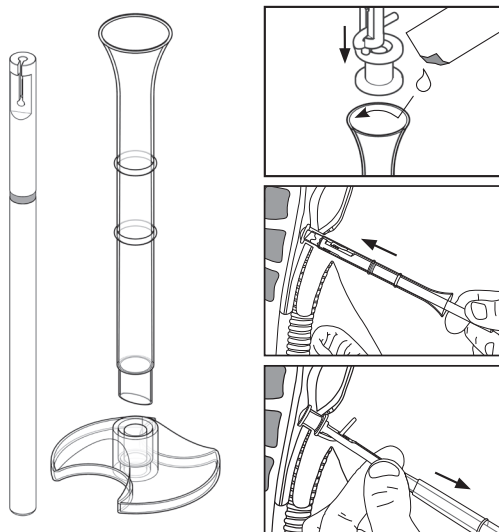
**Produkt****LARYVOX® INSERTER UNIEK PRO****VE**

1 Stück























**REF****25930**

























# LARYVOX® INSERTER

## ZUORDNUNG

25900	25910	25915	25920	25925 25930
LARYVOX® INSERTER	LARYVOX® INSERTER EXPERT	LARYVOX® INSERTER EXPERT SMALL	LARYVOX® INSERTER SPECIAL	LARYVOX® INSERTER UNIEK + UNIEK PRO
Farbe				
				
				

Achten Sie vorher auf die Länge (xx) der einzusetzenden Stimmprothese.

REF	Bezeichnung Stimmprothese	Länge	INSERTER
20 FRENCH			
AD20xx-NS	ADVANTAGE Indwelling 20 Fr. Voice Prosthesis	06-14 mm	
AD2004-NS	ADVANTAGE Indwelling 20 Fr. Voice Prosthesis	04 mm	
AS20xx-NS	ADVANTAGE Indwelling 20 Fr. Voice Prosthesis	06-14 mm	
AS2004-NS	ADVANTAGE Indwelling 20 Fr. Voice Prosthesis	04 mm	
DV20xx-LF	DUAL VALVE Indwelling LF 20 Fr. Voice Prosthesis	06-14 mm	
DV20xx-NS	DUAL VALVE Indwelling 20 Fr. Voice Prosthesis	06-14 mm	
IN2004-NS	CLASSIC Indwelling 4 mm 20 Fr. Voice Prosthesis	04 mm	
IN20xx-NS	CLASSIC Indwelling 20 Fr. Voice Prosthesis	06-20 mm	
IN2004-LEF	CLASSIC Indwelling LEF 4 mm 20 Fr. Voice Prosthesis	04 mm	
IN20xx-LEF	CLASSIC Indwelling LEF 20 Fr. Voice Prosthesis	06-14 mm	
IN20xx-IR	CLASSIC Indwelling IR 20 Fr. Voice Prosthesis	06-12 mm	
IN2004-LEIR	CLASSIC Indwelling LEIR 20 Fr. 4 mm Voice Prosthesis	04 mm	
IN20xx-LEIR	CLASSIC Indwelling LEIR 20 Fr. Voice Prosthesis	06-08 mm	
IN20xx-LESL	CLASSIC Indwelling LESL 20 Fr. Voice Prosthesis	05 und 07 mm	
IN2004-LETO	TEP Occluder Indw. LETO 20 Fr. 4 mm Voice Prosthesis	04 mm	
IN20xx-LETO	TEP Occluder Indw. LETO 20 Fr. Voice Prosthesis	06-14 mm	
IN2004-LF	CLASSIC Indwelling LF 20 Fr. 4 mm Voice Prosthesis	04 mm	
IN20xx-LF	CLASSIC Indwelling LF 20 Fr. Voice Prosthesis	06-14 mm	
IN20xx-SL	CLASSIC Indwelling SL 20 Fr. Voice Prosthesis	05,07 und 09 mm	
IN20xx-SO	CLASSIC Indwelling STERIL 20 Fr. Voice Prosthesis	08-14 mm	
25010-xx	LARYVOX® Uniek U.L.R. 21 Fr.	05-13 mm	
25020-xx	LARYVOX® Uniek U.L.R. 24 Fr.	05-13 mm	

REF	Bezeichnung Stimmprothese	Länge	INSERTER
16 FRENCH			
AS1604-NS	ADVANTAGE Indwelling 16 Fr. Voice Prosthesis	04 mm	
AS16xx-NS	ADVANTAGE Indwelling 16 Fr. Voice Prosthesis	06-14 mm	
IN1604-NS	CLASSIC Indwelling 4 mm 16 Fr. Voice Prosthesis	04 mm	
IN16xx-NS	CLASSIC Indwelling 6 mm 16 Fr. Voice Prosthesis	06-20 mm	
IN16xx-SO	CLASSIC Indwelling STERIL 10 mm 16 Fr. Voice Prosthesis	08-14 mm	
IN16xx-IR	CLASSIC Indwelling IR 16 Fr. Voice Prosthesis	06-12 mm	
IN1604-LEF	CLASSIC Indwelling LEF 4 mm 16 Fr. Voice Prosthesis	04 mm	
IN16xx-LEF	CLASSIC Indwelling LEF 16 Fr. Voice Prosthesis	06-14 mm	
IN16xx-LESL	CLASSIC Indwelling LESL 16 Fr. Voice Prosthesis	05 und 07 mm	
IN1604-LETO	CLASSIC Indwelling LETO 4 mm 16 Fr. Voice Prosthesis	04 mm	
IN16xx-LETO	CLASSIC Indwelling LETO 16 Fr. Voice Prosthesis	06-14 mm	
IN1604-LF	CLASSIC Indwelling LF 4 mm 16 Fr. Voice Prosthesis	04 mm	
IN16xx-LF	CLASSIC Indwelling LF 16 Fr. Voice Prosthesis	06-14 mm	
IN16xx-SL	CLASSIC Indwelling SL 16 Fr. Voice Prosthesis	05,07 und 09 mm	
IN16xx-SO	CLASSIC Indwelling STERIL 16 Fr. Voice Prosthesis	08-14 mm	
Einsatz mit Gel-Kapsel-Technik			
IN20xx-NS	CLASSIC Indwelling 20 Fr. Voice Prosthesis	06-20 mm	
AD20xx-NS	ADVANTAGE Indwelling 20 Fr. Voice Prosthesis	06-14 mm	
AS20xx-NS	ADVANTAGE Indwelling 20 Fr. Voice Prosthesis	06-14 mm	
IN20xx-LF	CLASSIC Indwelling LF 20 Fr. Voice Prosthesis	06-14 mm	
IN20xx-LEF	CLASSIC Indwelling LEF 20 Fr. Voice Prosthesis	06-14 mm	
IN20xx-SL	CLASSIC Indwelling SL 20 Fr. Voice Prosthesis	05,07 und 09 mm	
IN20xx-LEIR	CLASSIC Indwelling LEIR 20 Fr. Voice Prosthesis	05 und 07 mm	
IN20xx-LESL	CLASSIC Indwelling LESL 20 Fr. Voice Prosthesis	05 und 07 mm	
IN20xx-IR	CLASSIC Indwelling IR 20 Fr. Voice Prosthesis	06-12 mm	
IN20xx-LETO	TEP Occluder Indw. LETO 20 Fr. Voice Prosthesis	06-14 mm	



Die Andreas Fahl Medizintechnik-Vertrieb GmbH ist exklusiver Vertriebspartner für Blom-Singer®-Produkte in ausgewählten Ländern Europas. Blom-Singer® ist eine eingetragene Marke der Freudenberg Medical, LLC.